

## SCHEDA TECNICA - HP112 1B INT

### CORPO LAMPADA "A"

materiale	tondino metallico nervato	
colore	bianco opaco	

### CAVO ELETTRICO "C"

materiale	telato intrecciato	
colore	nero	

### DISPOSITIVO ELETTRICO

portalampade	E27
sorgente luminosa	max 3x77w
classe energetica	da E a A++





### PACKAGING

n° colli	1
peso netto/kg	9,7
peso lordo/kg	17
imballo/cm	68x67x173

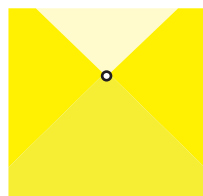
### EMISSIONE LUMINOSA

unidirezionale



	diretta
	filtrata
	indiretta
	assenza

### CERTIFICAZIONI

IEC	60598-1:2008
EN	60598-1:2008 + A11:2009



grado di protezione lampadina	IP20 opzionale
----------------------------------	-------------------



articolo **700L**  
filamenti di tungsteno  
E27 - 25w - ≤ 60 lumen  
classe E

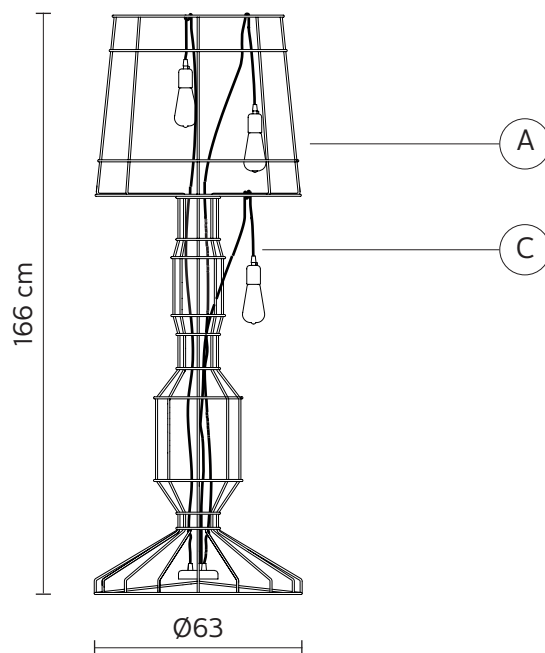

### COLLEZIONE

disponibile anche nella versione sospensione



HP112 1T INT