

# CERAUNAVOLTA

SE134 2S 00A (a)

SE134 2T 00A (a)

SE134 3S 00C (a)

SE134 3T 00C (a)

SE134 1S 00D (b)

SE134 1T 00D (b)

220-240V

3 x max 20W LED - E27

4 x max 20W LED - E27

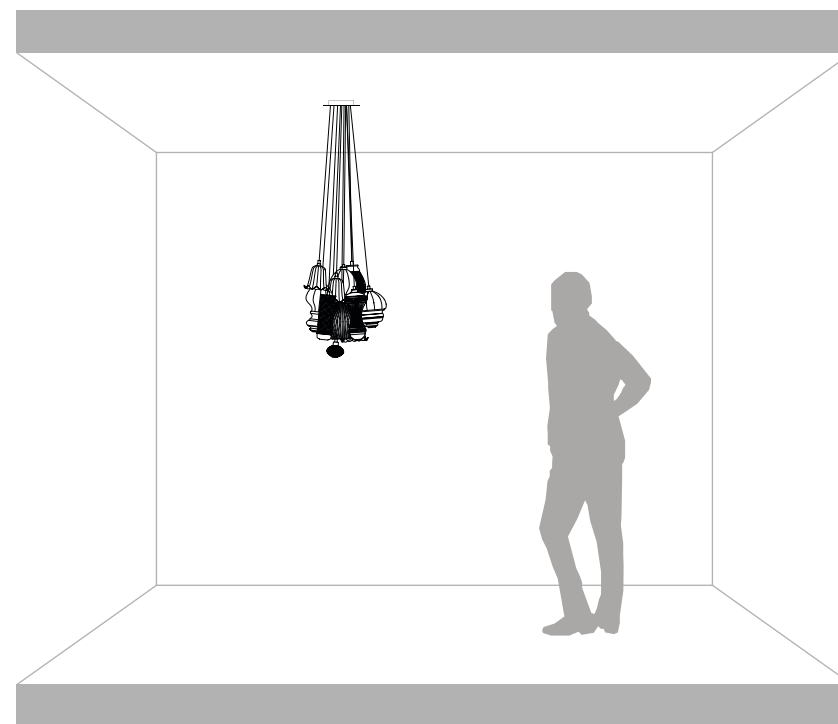

Karman srl

Via A. Grandi, San Martino del piano, 61034 Fossombrone (PU), Italy - p.iva 02175640412 tel +39 0721 71 5042 r.a fax +39 0721 716640 - [www.karmanitalia.it](http://www.karmanitalia.it)



# C - 01

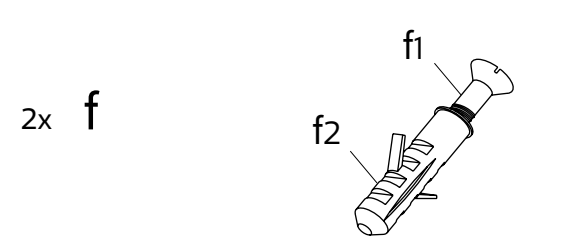
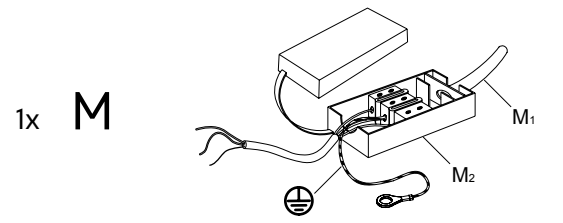
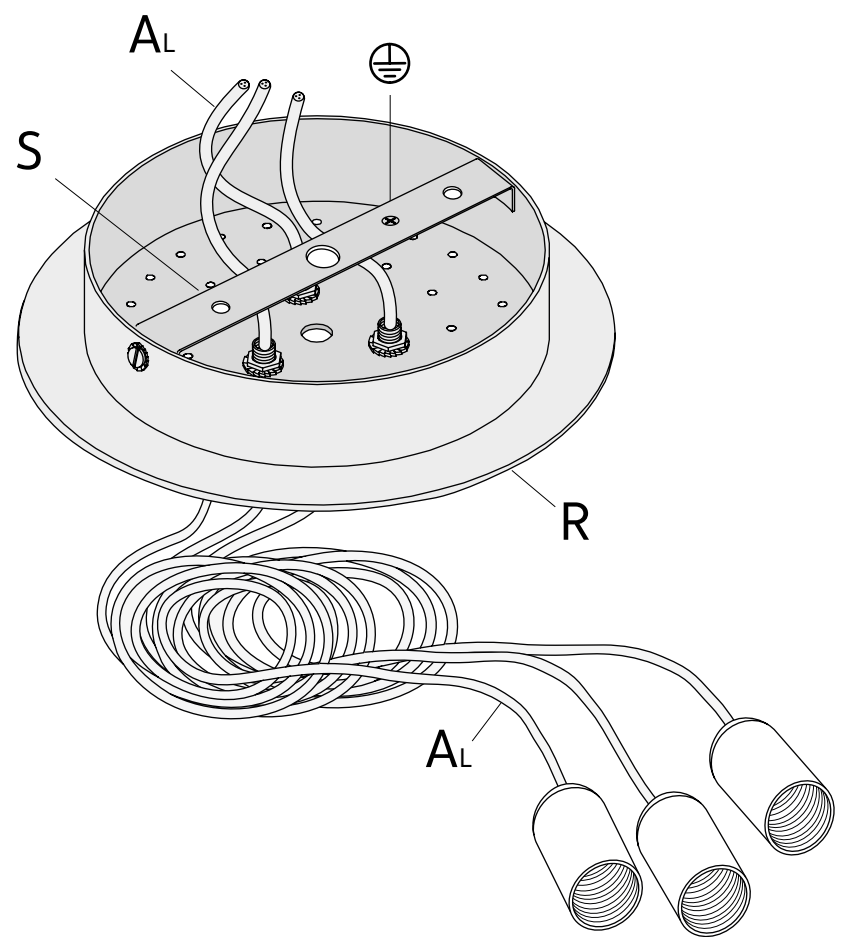

12x **C<sub>a</sub>** SE134 2S 00A  
SE134 2T 00A

12x **T** SE134 2S 00A  
SE134 2T 00A

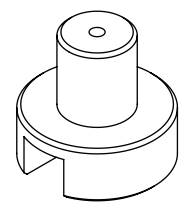

17x **C<sub>a</sub>** SE134 3S 00C  
SE134 3T 00C

17x **T** SE134 3S 00C  
SE134 3T 00C

22x **C<sub>a</sub>** SE134 1S 00D  
SE134 1T 00D

22x **T** SE134 1S 00D  
SE134 1T 00D

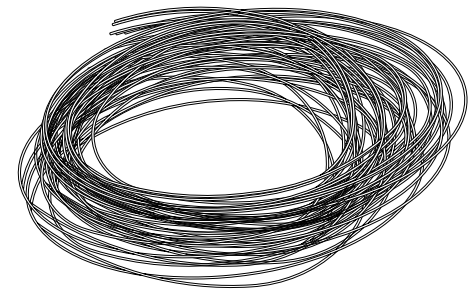

12x **O** SE134 2S 00A  
SE134 2T 00A

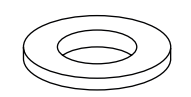

17x **O** SE134 3S 00C  
SE134 3T 00C

22x **O** SE134 1S 00D  
SE134 1T 00D

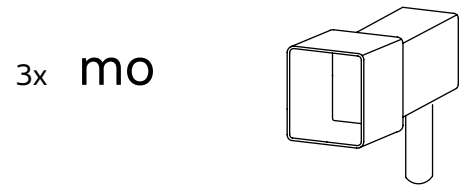

12x **A** SE134 2S 00A  
SE134 2T 00A

17x **A** SE134 3S 00C  
SE134 3T 00C

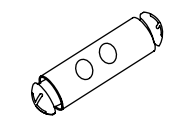

22x **A** SE134 1S 00D  
SE134 1T 00D

12x **P<sub>A</sub>** SE134 2S 00A  
SE134 2T 00A

17x **P<sub>A</sub>** SE134 3S 00C  
SE134 3T 00C

17x **C<sub>a</sub>** SE134 1S 00D  
SE134 1T 00D

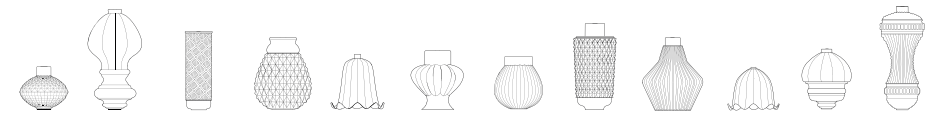

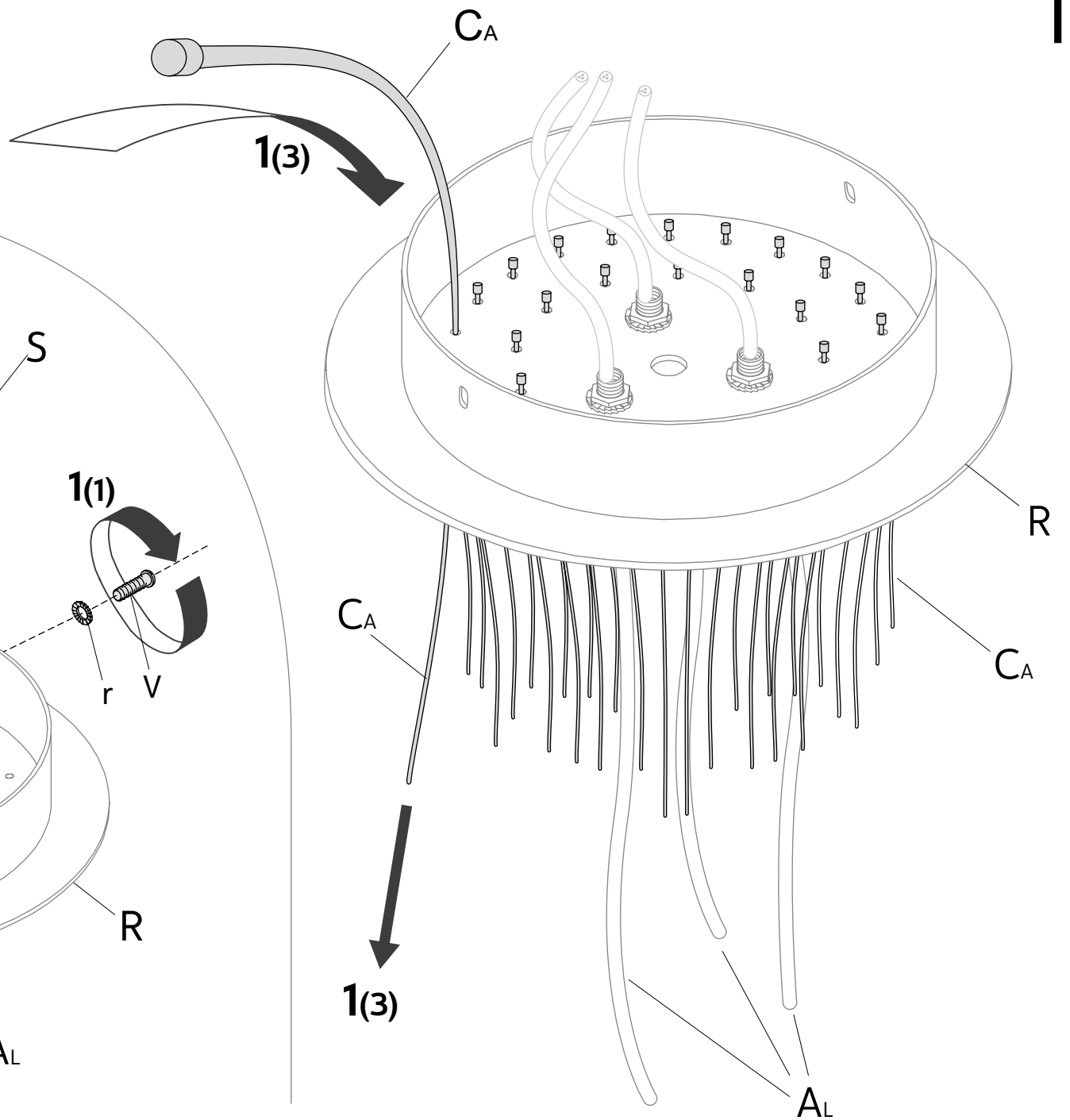
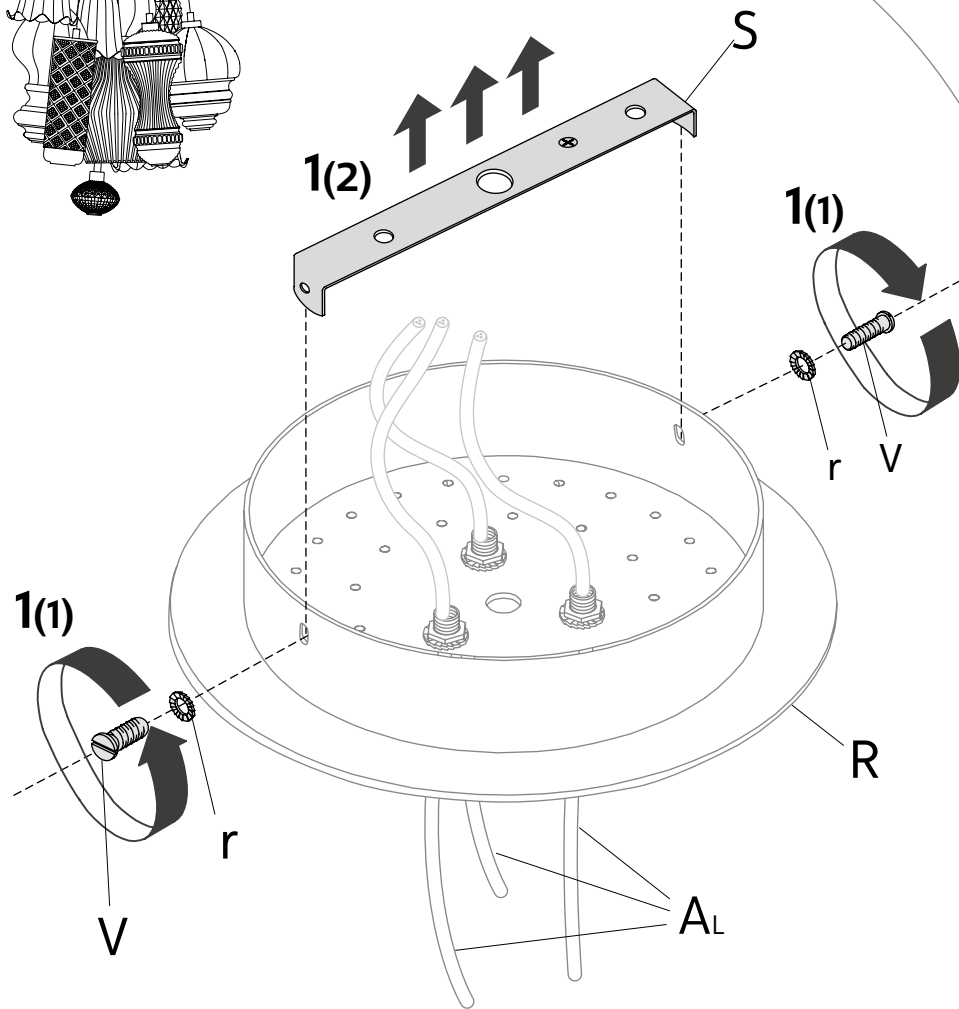
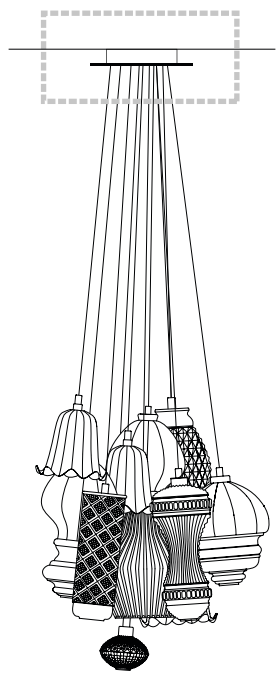

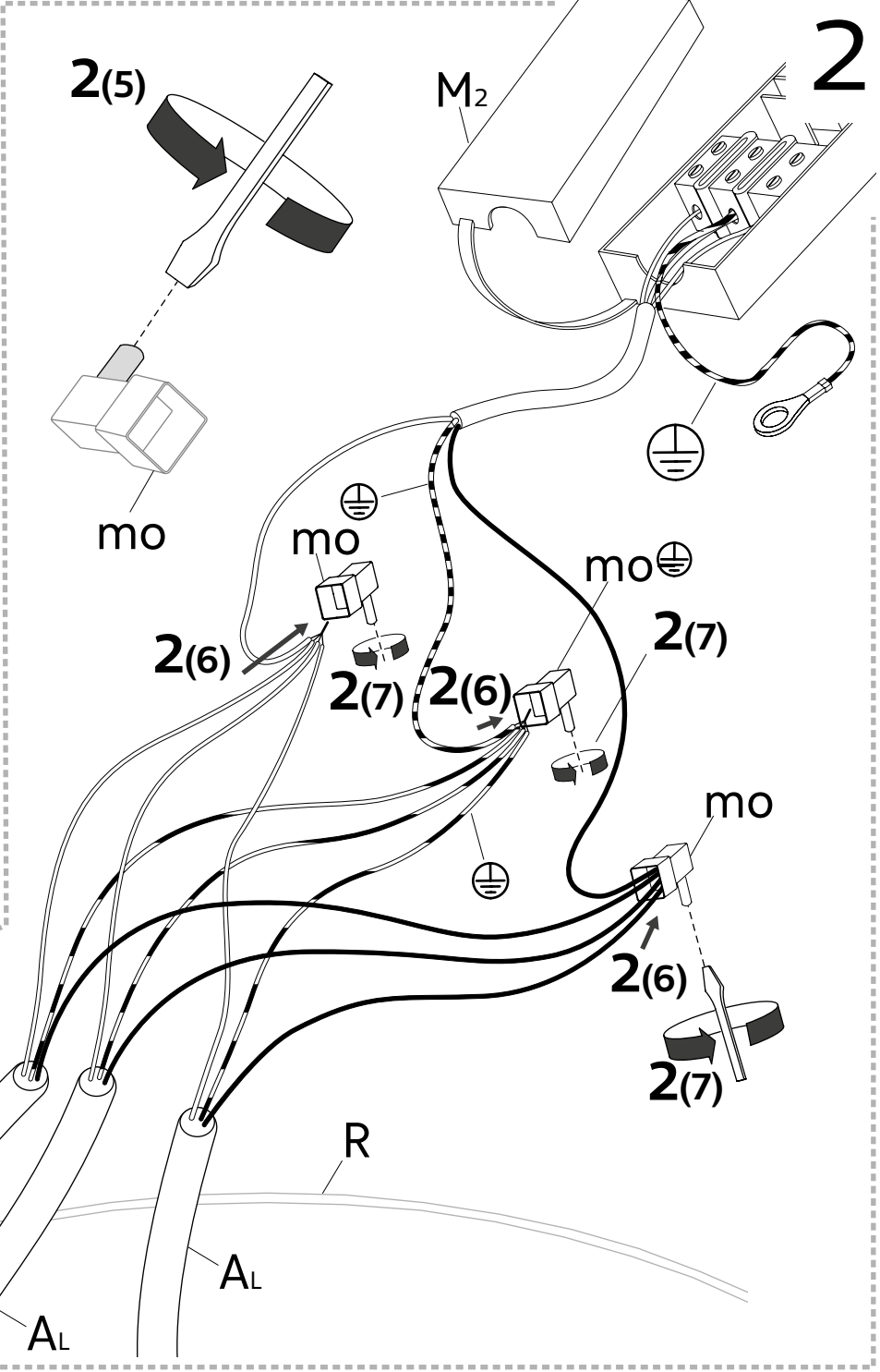
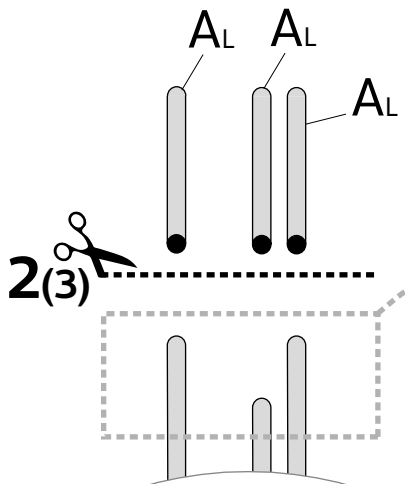
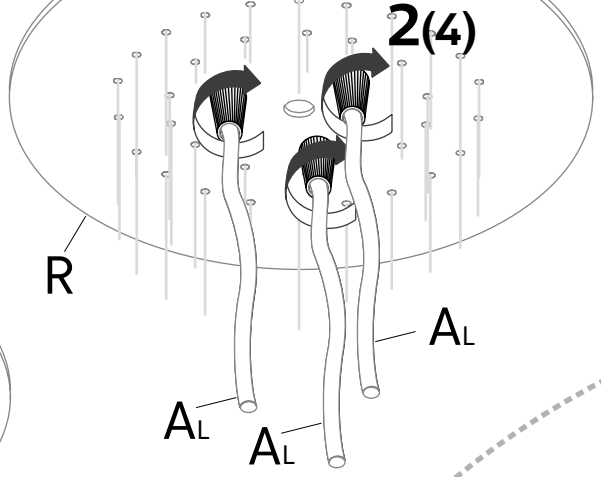
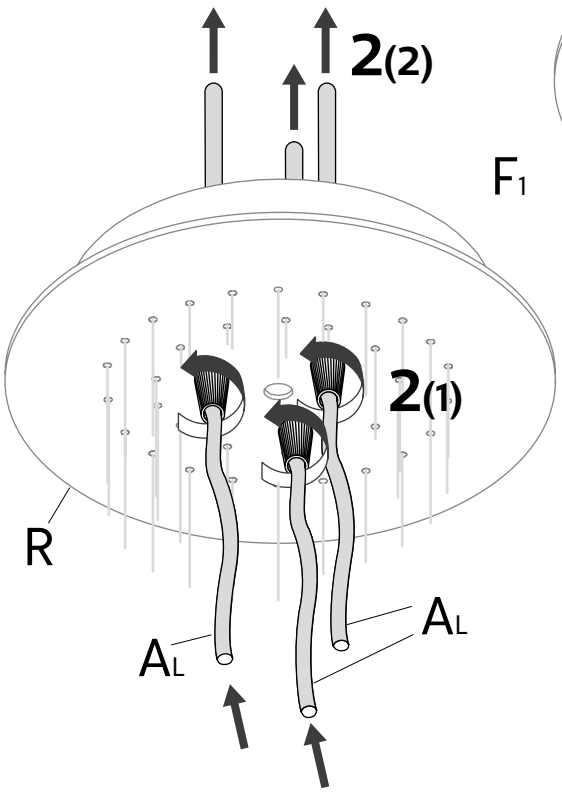
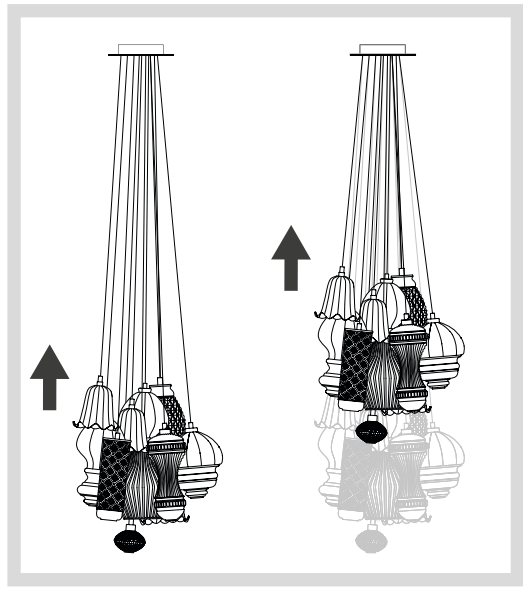

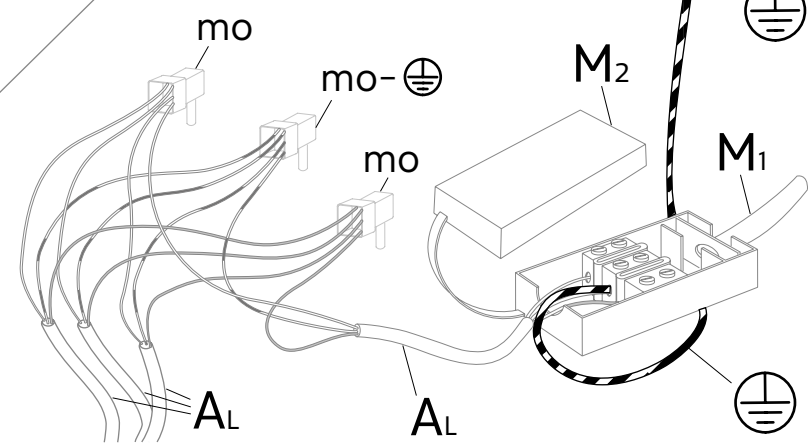
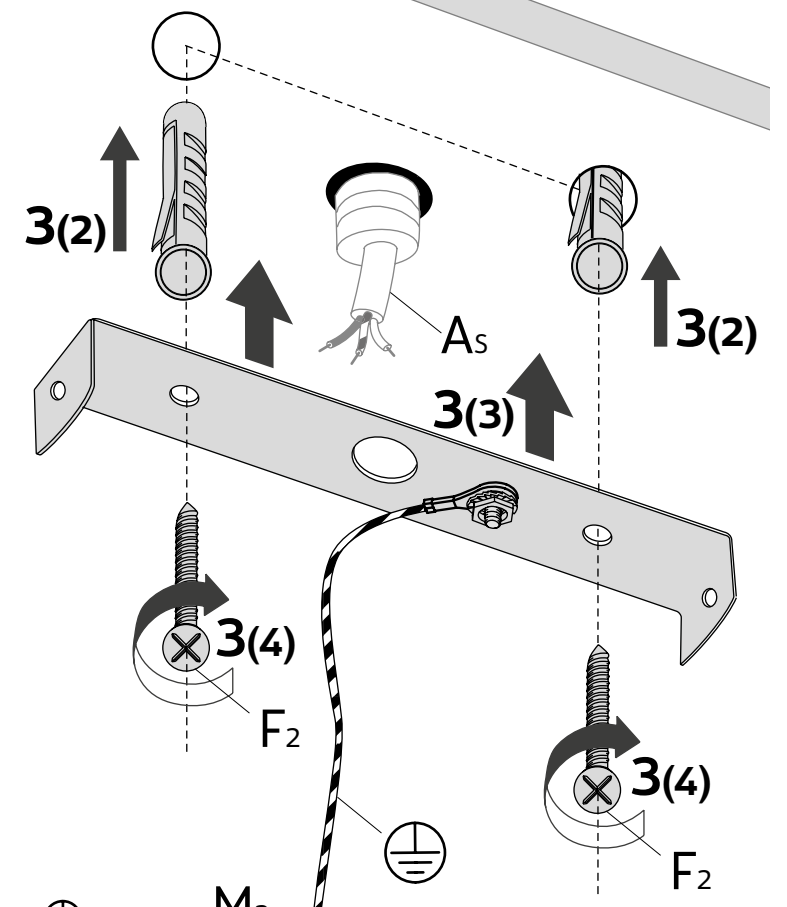
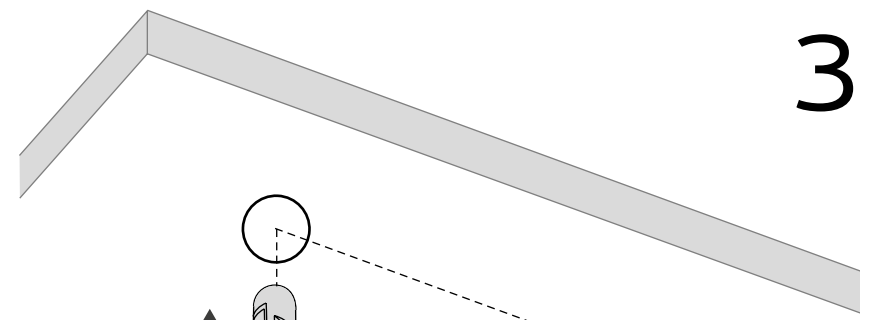
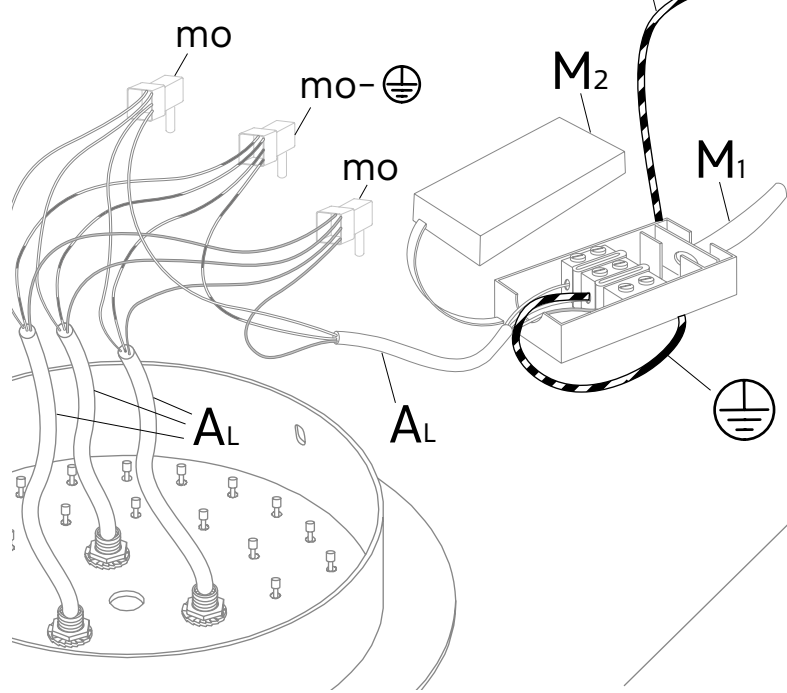
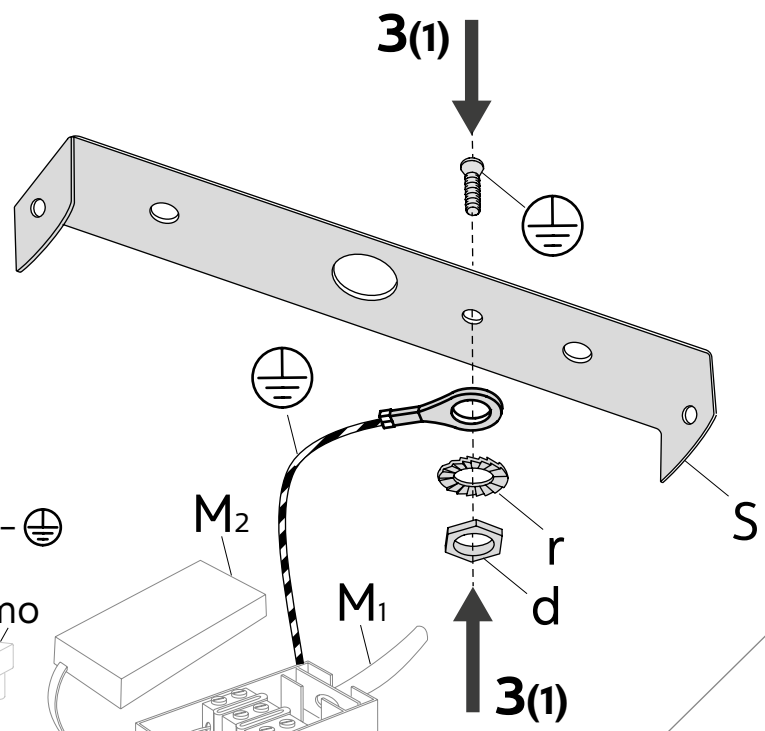
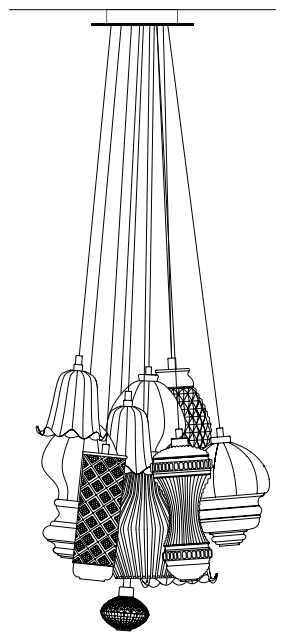

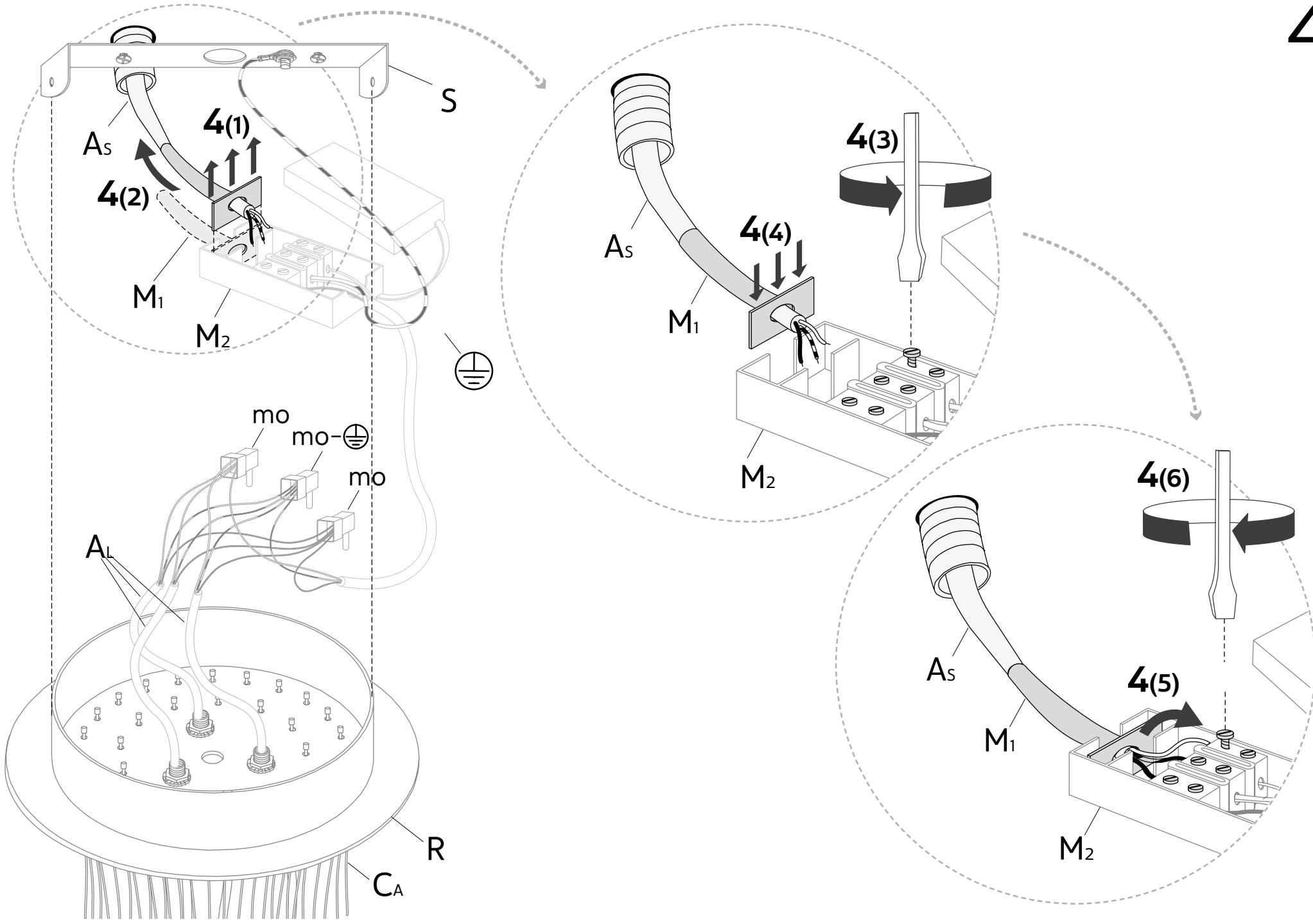

5

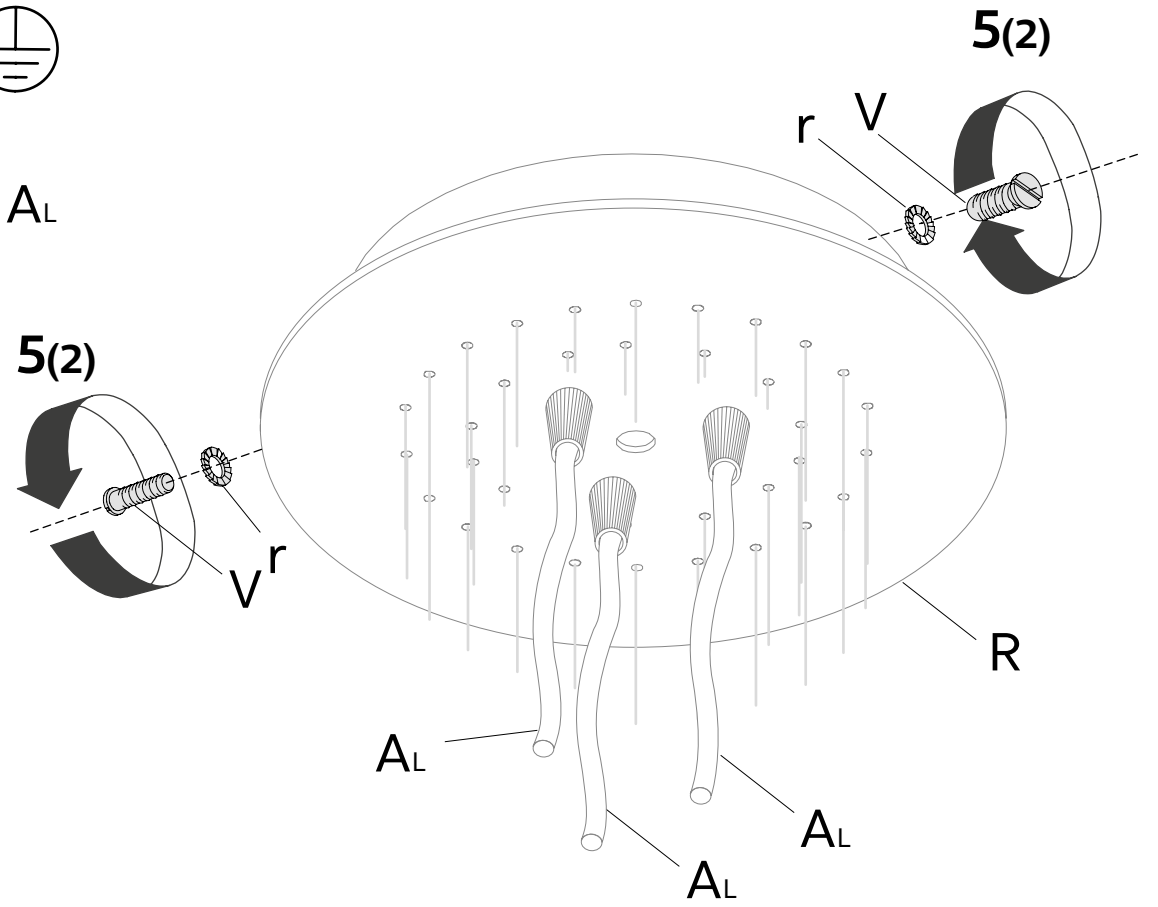
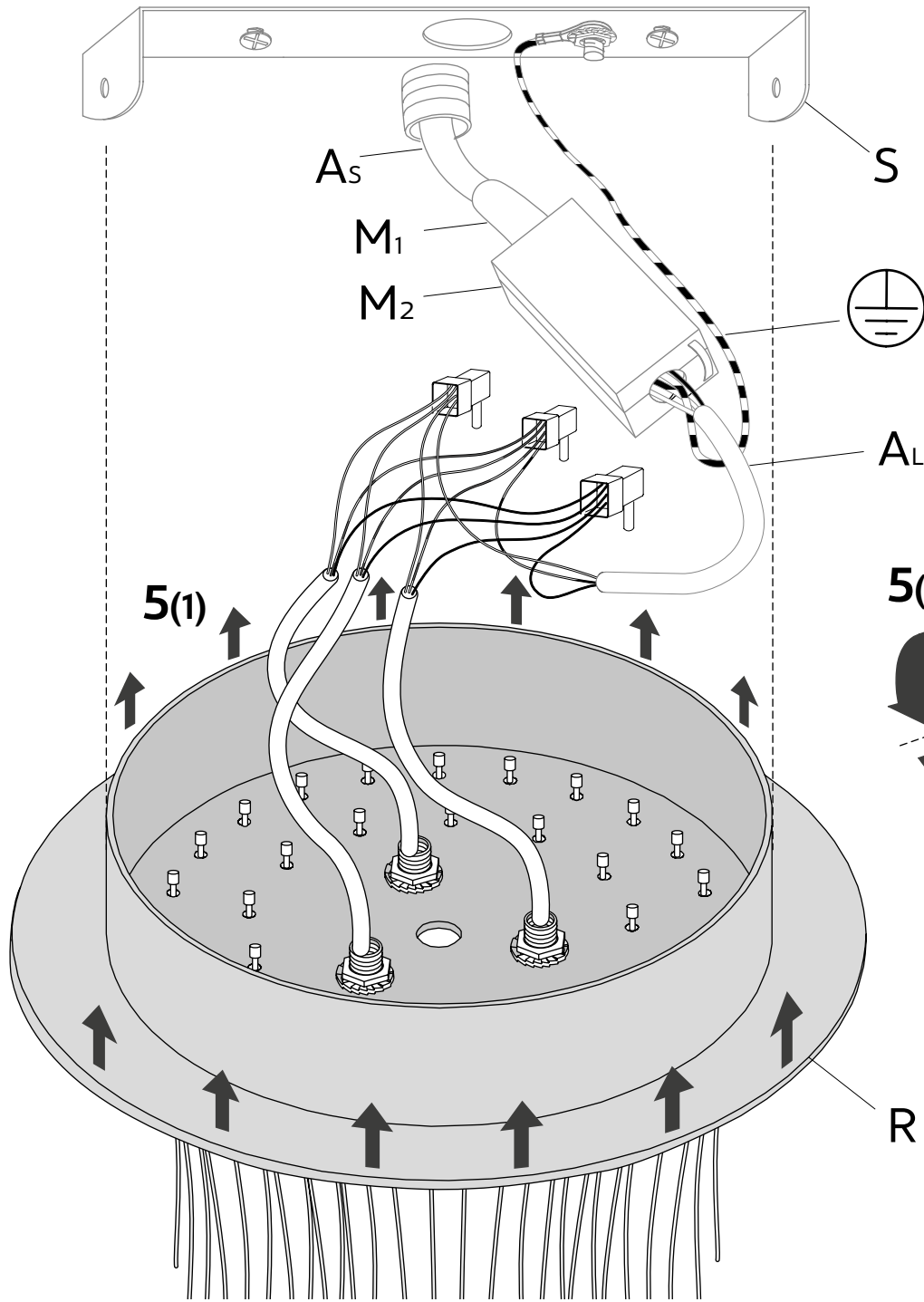



6

