

DOMENICA

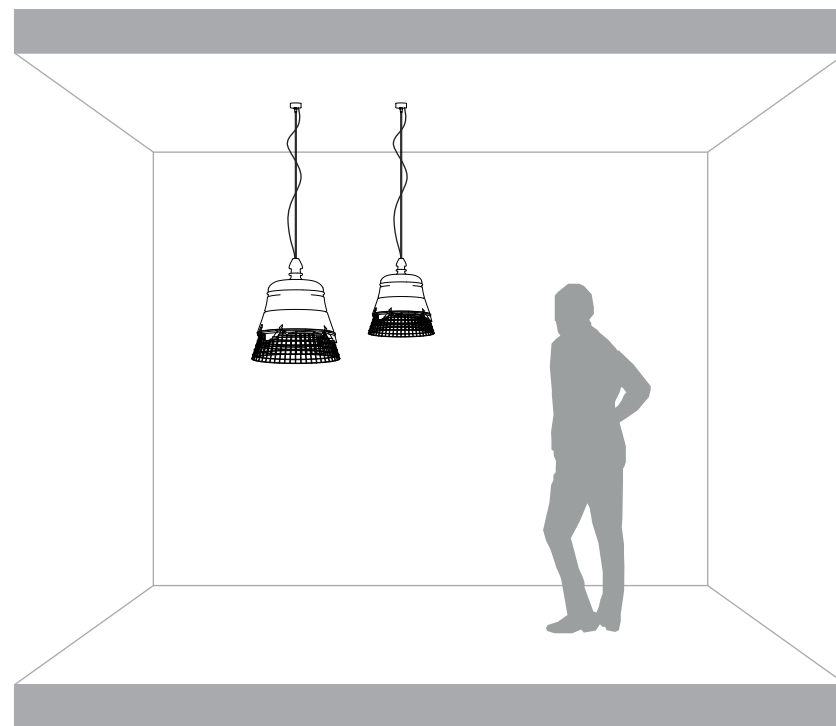

SE102 1B INT
SE102 1O INT
SE102 2B INT
SE102 2O INT

220-240 V.
max 1x70W - E27



Karman srl

Via A. Grandi, San Martino del piano, 61034 Fossombrone (PU), Italy - p.iva 02175640412 tel +39 0721 71 5042 r.a fax +39 0721 716640 - www.karmanitalia.it

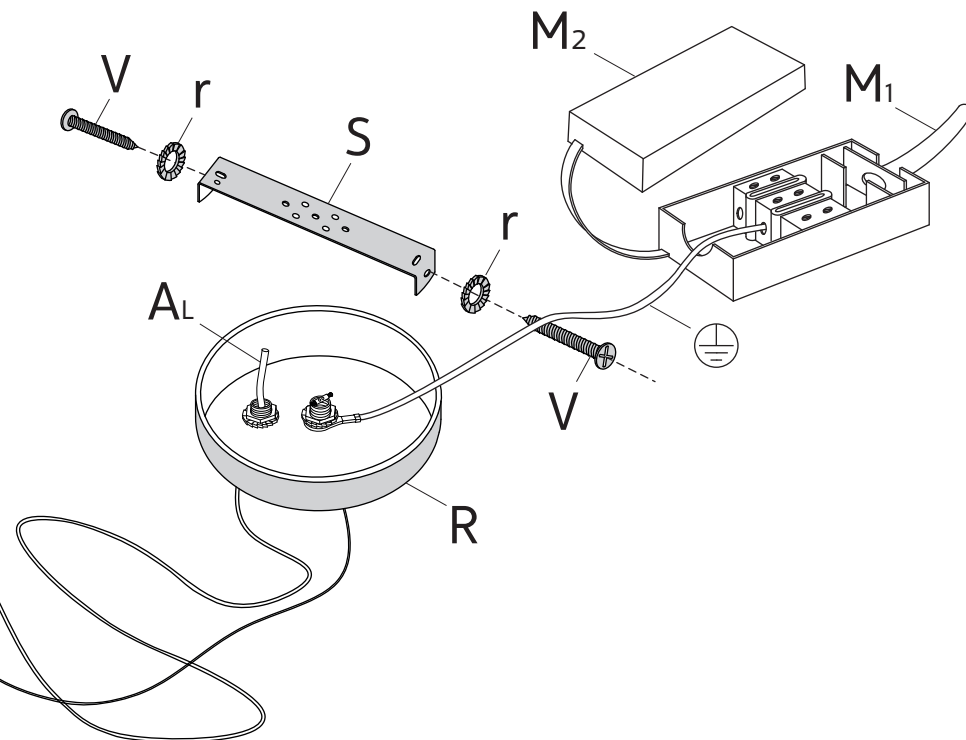
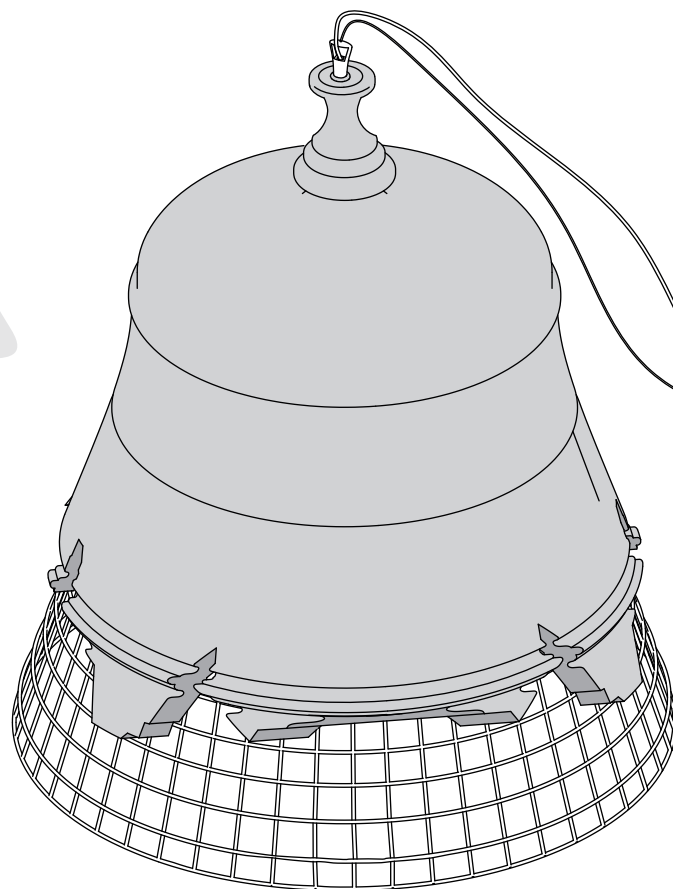
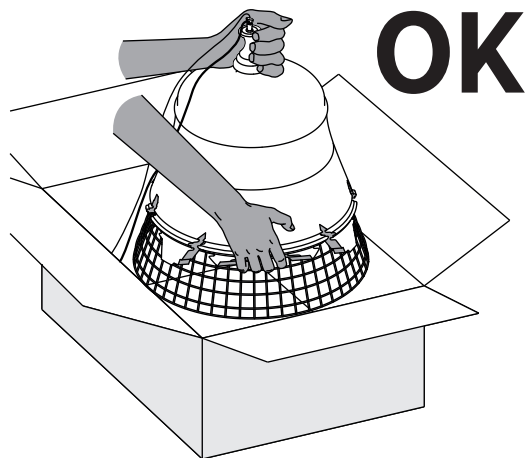

2x F

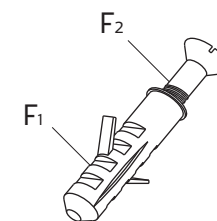

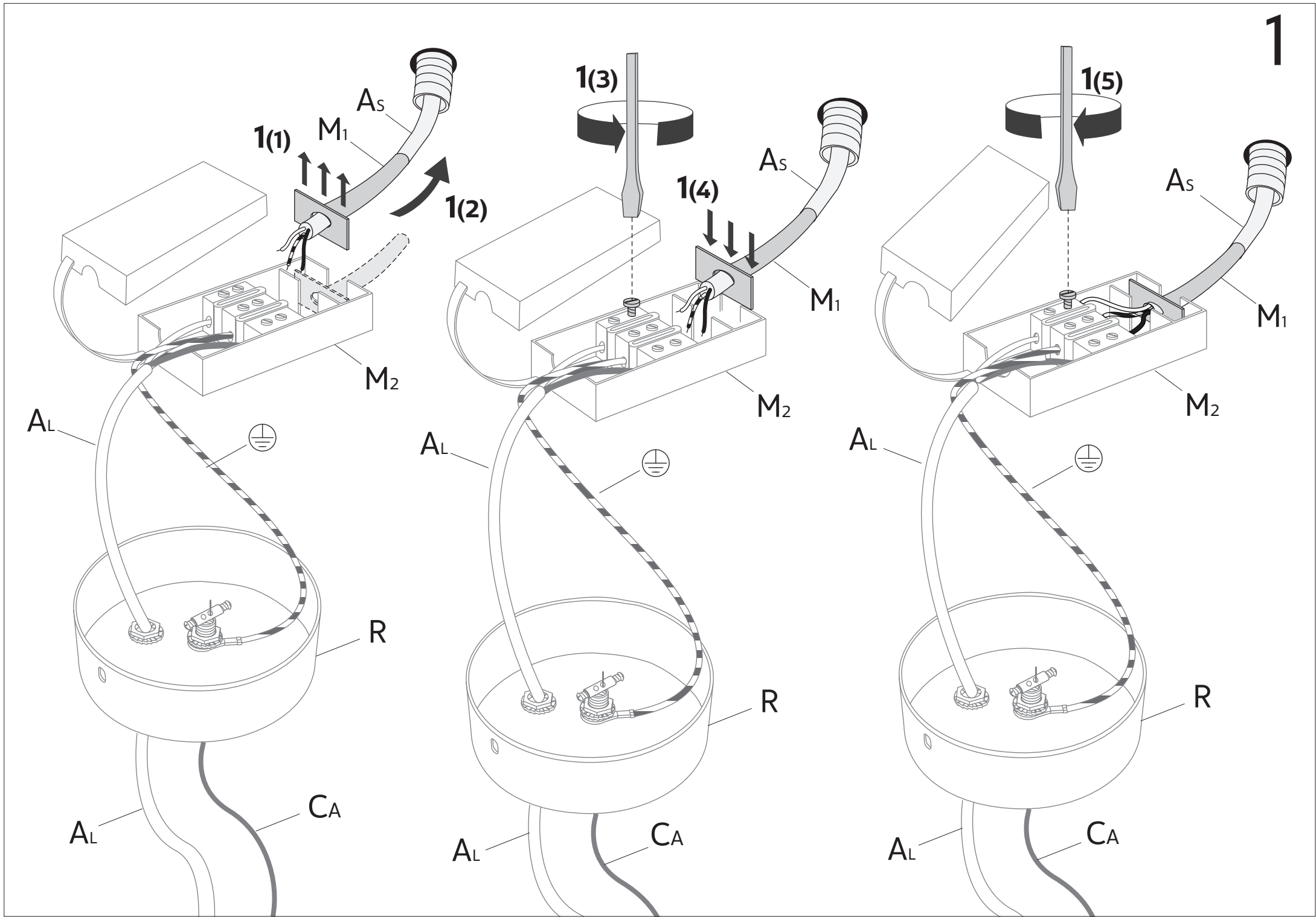

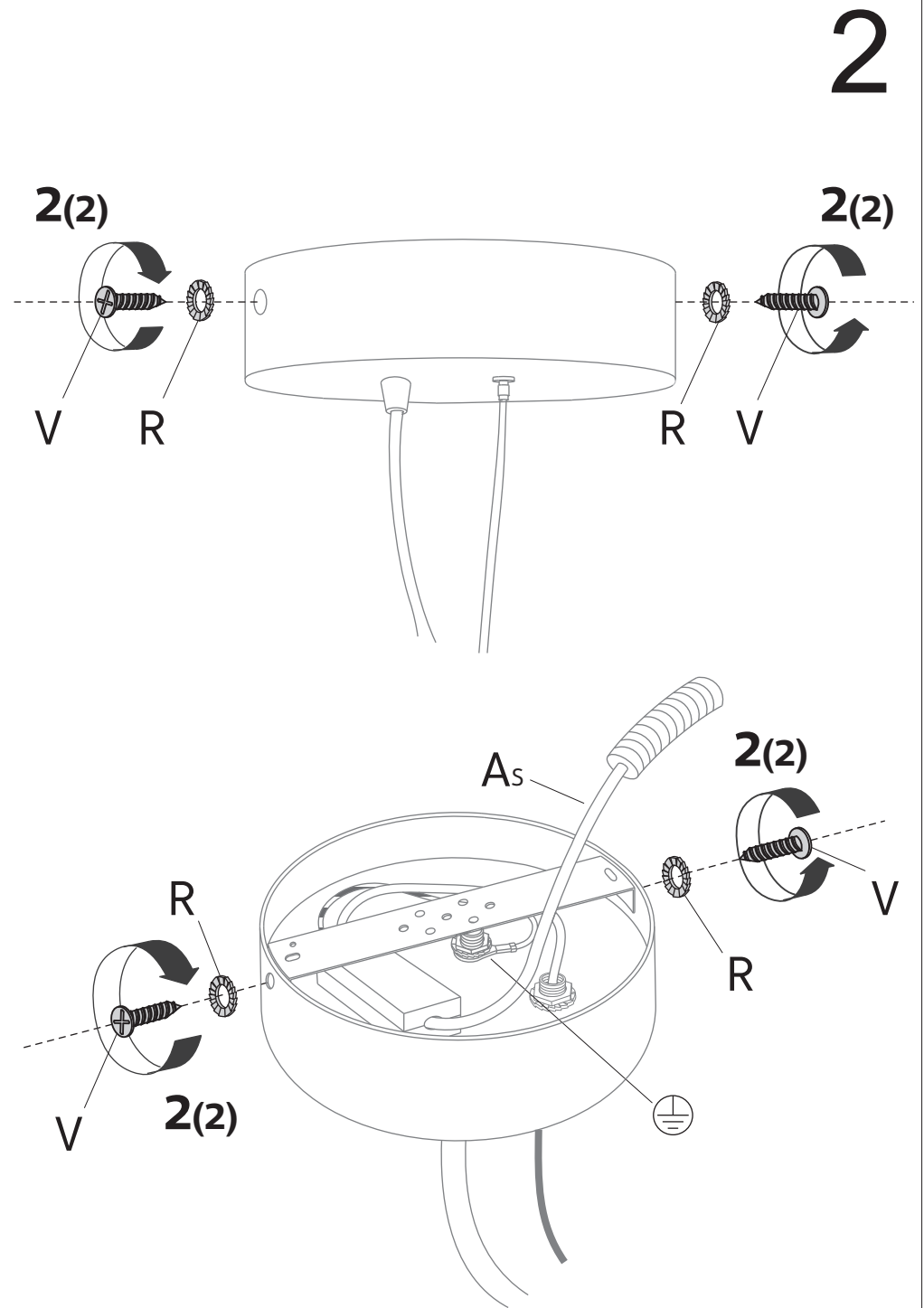
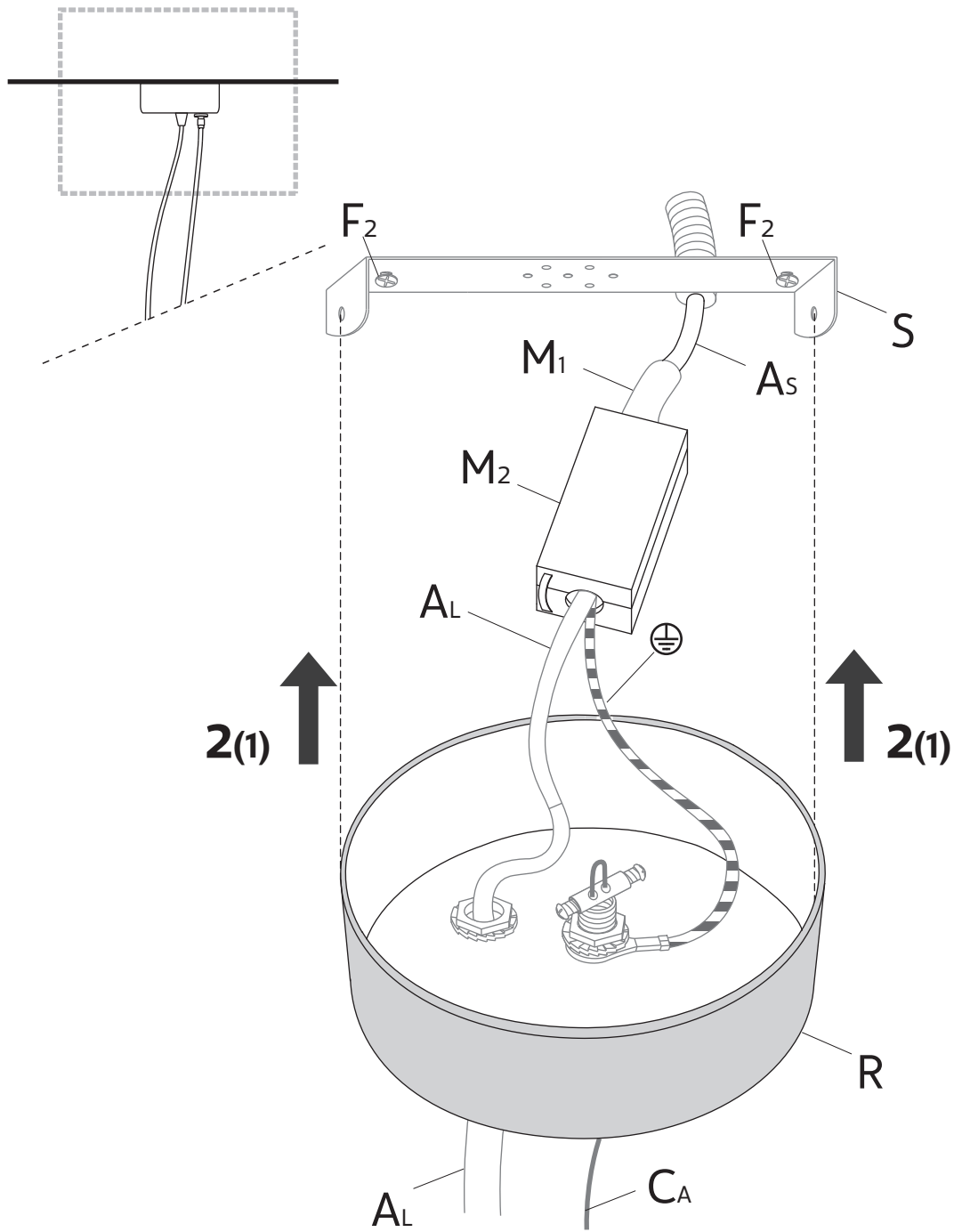

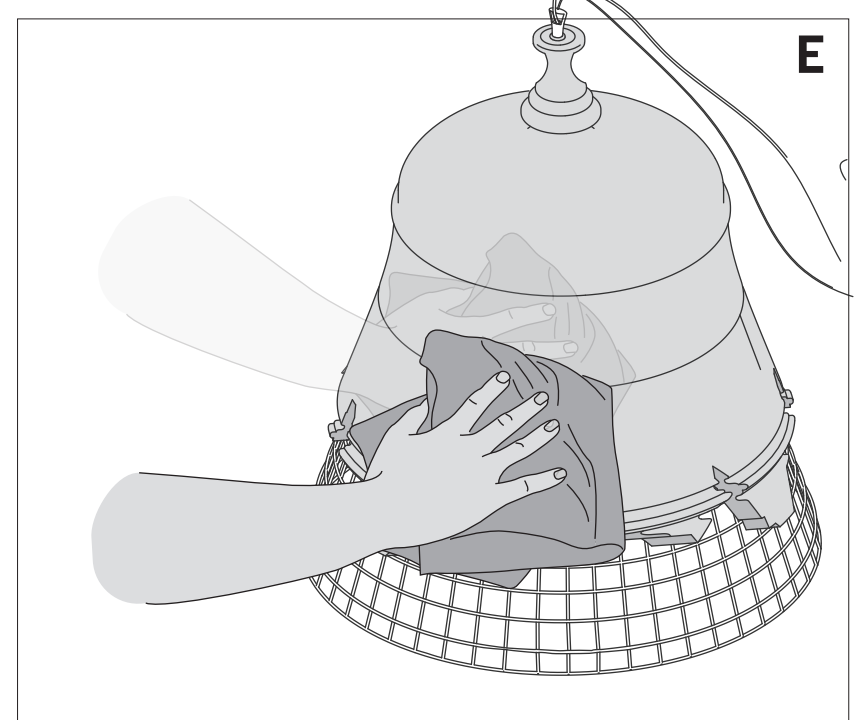
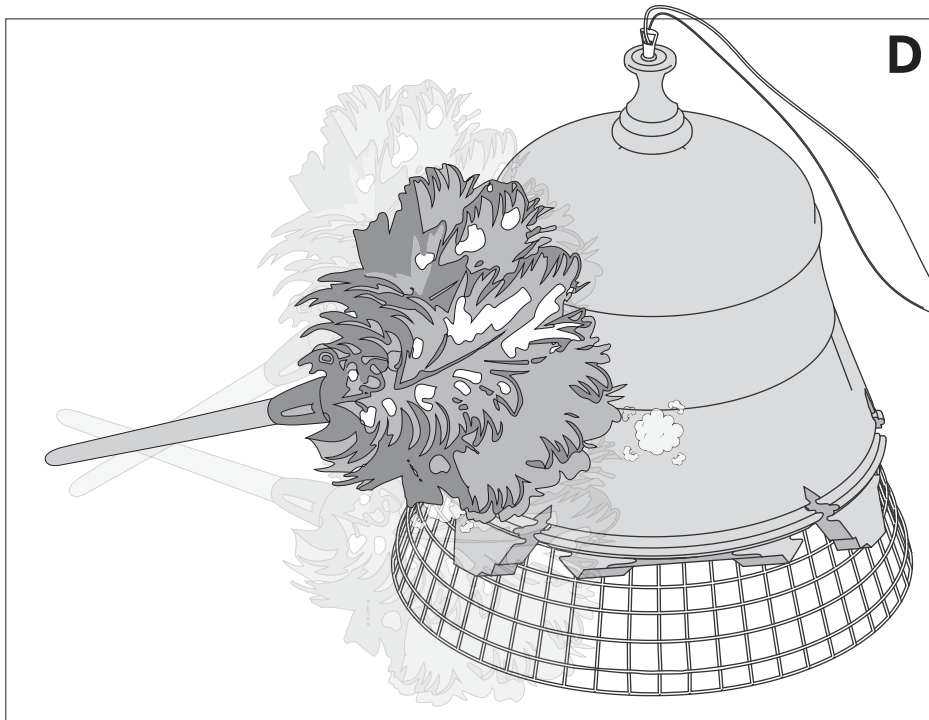
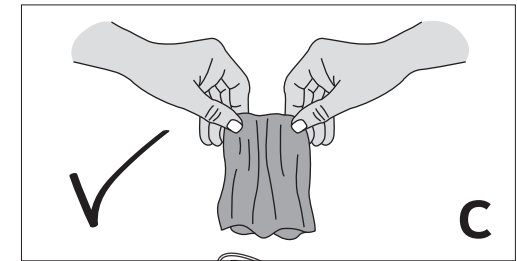
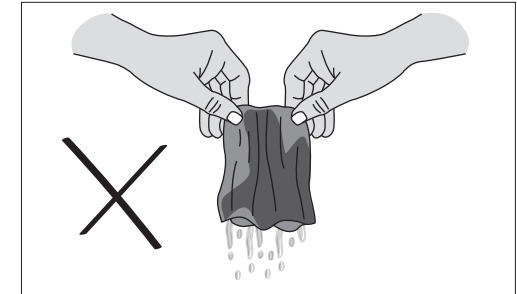
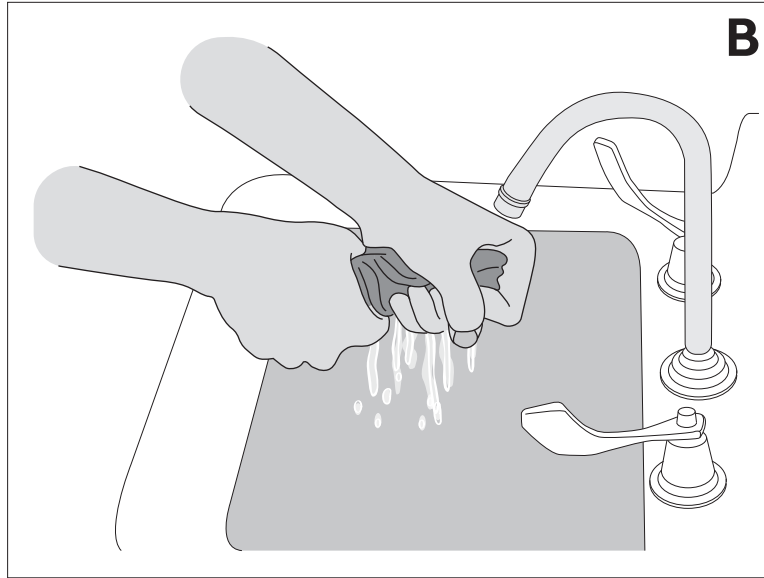
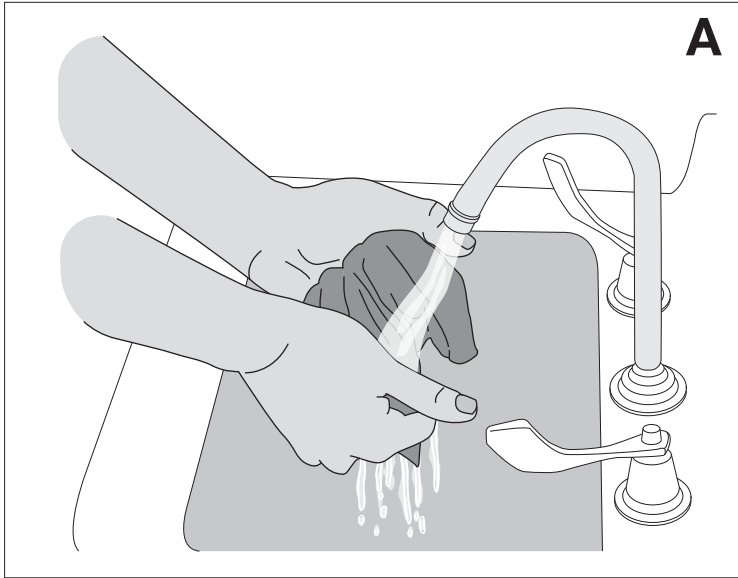

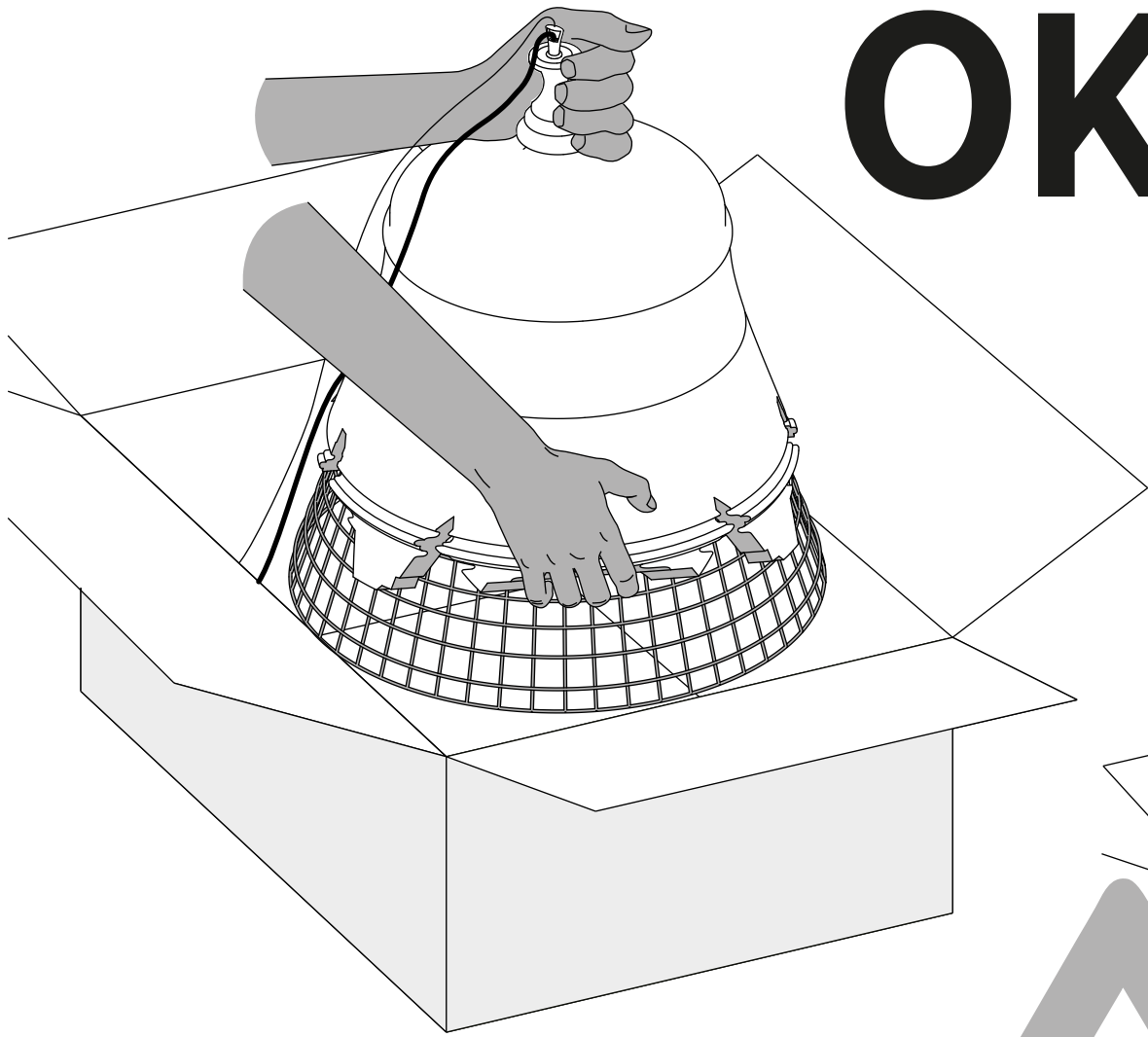

OK

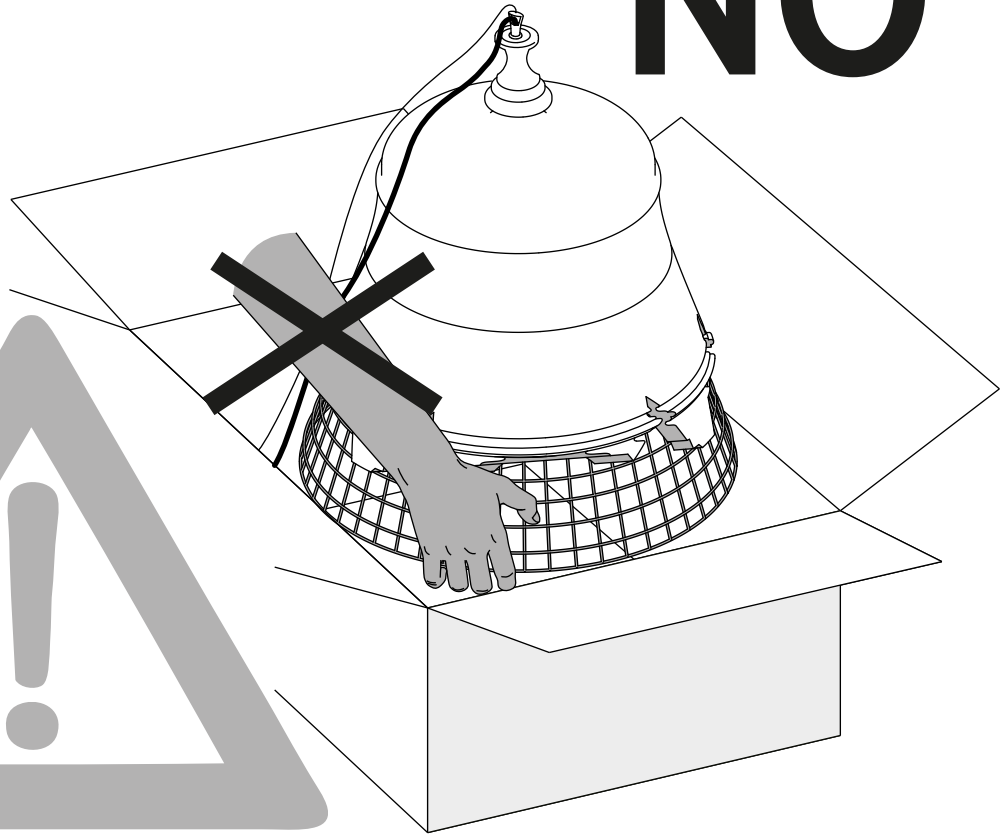

NO

